

Link **LED**



[**DALI 2.0 Dimming**]
5 years warranty



Specification For LED Tri-Proof Light

PRODUCT NAME:

LED Tri-Proof Light

Item NO.:

SR05-36W-1230

SR05-50W-1530



Description:

- ★ Save money compared to traditional lamps.
- ★ Reliable LED technology for maintenance-free installation and long service life.
- ★ A direct replacement for traditional waterproof fixtures in terms of light.
- ★ Performance, installation flexibility and length.
- ★ Over 70% energy savings compared to conventional lamps with similar Lumen output.

Applications:

- ★ Indoor places: kitchens, bathrooms, basements, garages, storerooms, etc. It can cope with humidity, dust and water vapor indoors.
- ★ Industrial places: such as power plants, steel mills, petrochemical plants, ships, etc. These places have harsh environments and high protection requirements for lamps.
- ★ Outdoor environment: such as stadiums, parking lots, basements, etc., three-proof lights can work normally under the influence of wind and rain and other natural factors.
- ★ Special places: such as oceans, ships, hospital operating rooms, etc. These places have high lighting requirements, and the three-proof lamps can provide high-brightness lighting effects.

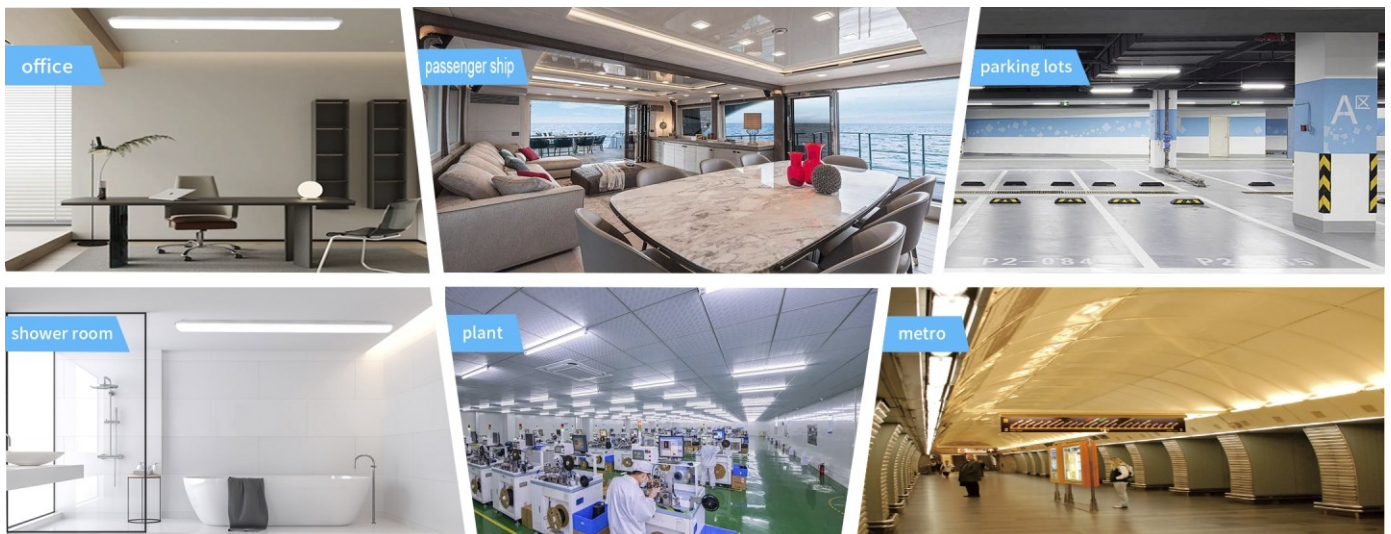



Photo

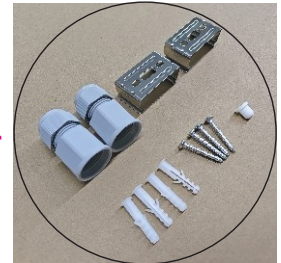

Install fittings



Press type electrical connector



When the cable is not out, the rubber plug can be installed



Tsong[®]

Link LED



Photo

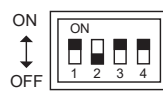
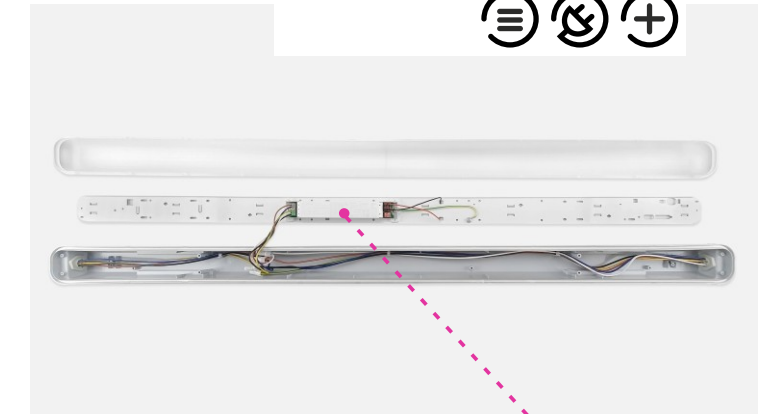
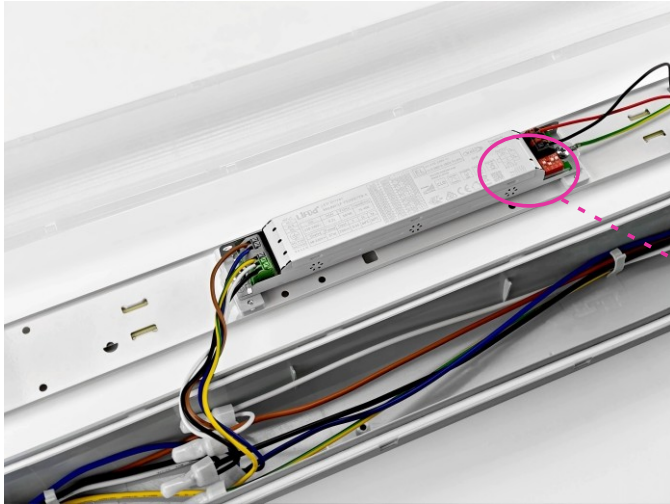

Power Adjustable

LIFUD[®] LED Driver

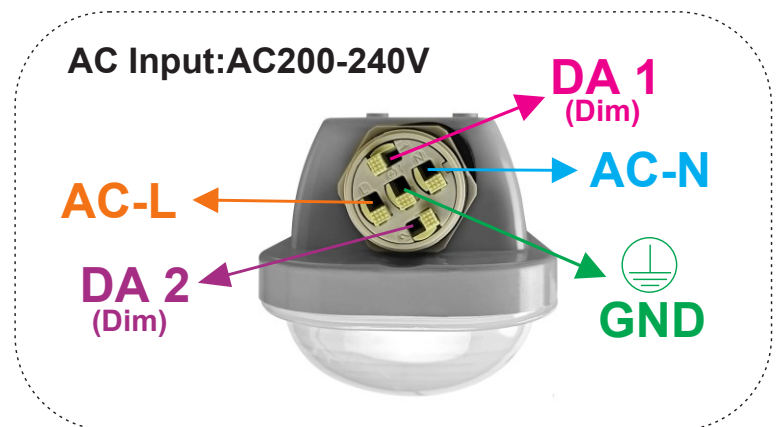

PRODUCT DESCRIPTION

- Body: PC Extrusion molding
- PC material, could meet Ik08 and 750 GWT requirement
- other characteristics : pollution free , low power consumption, high luminous efficiency & IP65
- High-low impact, high humidity environmental tests

Dimensions(Unit:mm)

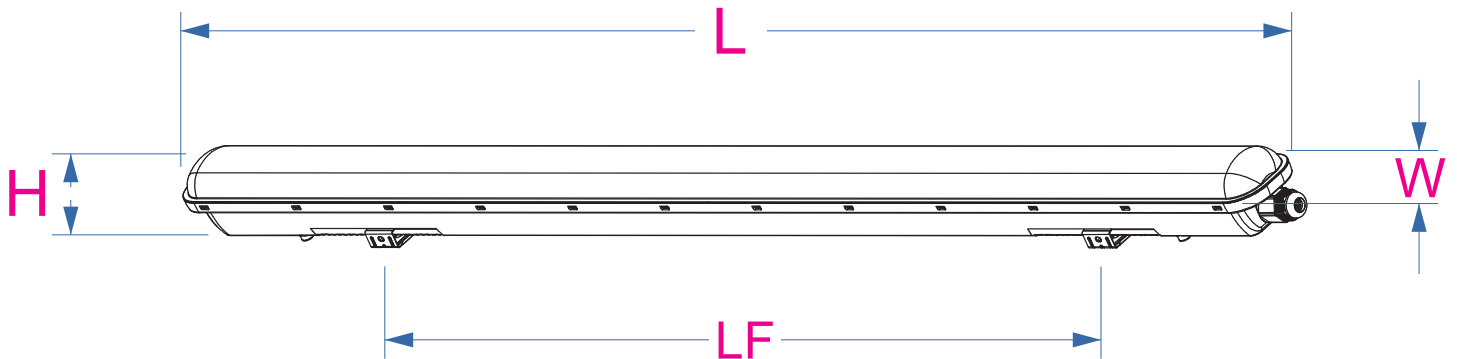
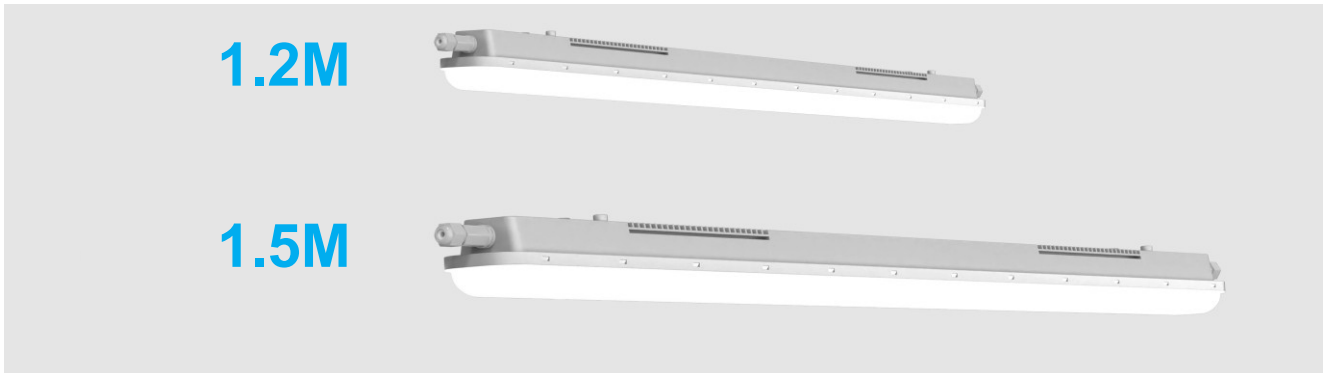

Item No.	Power	Product Size(L*W*H)	Fixing Hole Centre(LF)
SR05-25W-1230	25W	L1200*W68*H65mm	800mm
SR05-45W-1530	45W	L1500*W68*H65mm	1010mm



Electrical/Optical Characteristics/Specifications



Item No.: **SR05-36W-1230** **1.2M**

Input Voltage	Max.Current	Operating Voltage	Constant Current	Power Consumption	Power Factor	
AC200-240V	0.15A	DC99V	0.35A	36W	≥0.95	
LED Type	LED Q'ty	CRI	CCT	2900-3100K	4000-4500K	5500-6000K
			Luminous efficiency	150LM/W	155LM/W	155LM/W
SMD2835	132PCS	≥80Ra	Luminous flux	5400LM ± 10%	5580LM ± 10%	5580LM ± 10%
			Beam Angle	120°		
Life Time	Certifications	IP Code	Luminaires Class	product dimension	N.W	
50.000Hours	CE,RoHS	IP65	Class I	L1200*W68*H65mm	1.28Kg	
Operating Temperature	Storage Temperature	Humidity Operating	Humidity Storage	Packing dimension	G.W	
-20 °C to +50 °C	-30 °C to +60 °C	10-80%RH	10-90%RH	L1230*W77*H77mm	1.48Kg	
Outer carton package	9*1layer=9PCS/carton,K=K corrugated paper , L1245*W250*H250mm,GW:14.15KG					
Optional dimming type	DALI Dimming					
Power Adjustable	0.35A —36W 、 0.3A —30W 、 0.25A —24W 、 0.2A —20W					

Test report

Item No.: **SR05-36W-1230** **1.2M**

LUMINOUS INTENSITY DISTRIBUTION DIAGRAM

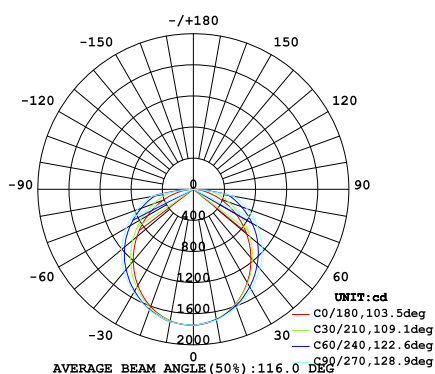

PLANAR ISOLUX DIAGRAM (UNIT: lx)

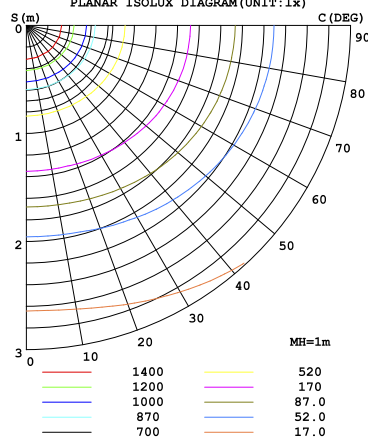

Flux out: 3265 lm

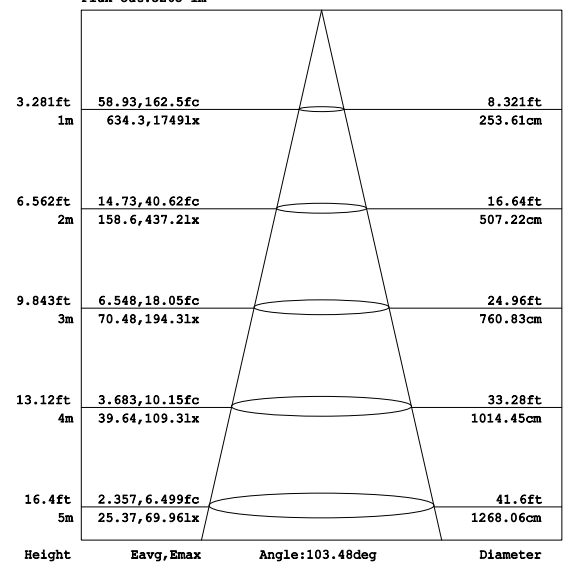

Note: The Curves indicate the illuminated area and the average illumination when the luminaire is at different distance.



Electrical/Optical Characteristics/Specifications

Item No.: **SR05-50W-1530**

1.5M



Input Voltage	Max.Current	Operating Voltage	Constant Current	Power Consumption	Power Factor	
AC200-240V	0.21A	DC138V	0.35A	50W	≥0.95	
LED Type	LED Q'ty	CRI	CCT	2900-3100K	4000-4500K	5500-6000K
			Luminous efficiency	150LM/W	155LM/W	155LM/W
SMD2835	184PCS	≥80Ra	Luminous flux	7500LM ±10%	7750LM ±10%	7750LM ±10%
			Beam Angle	120°		
Life Time	Certifications	IP Code	Luminaire Class	product dimension	N.W	
50.000Hours	CE,RoHS	IP65	Class I	L1500*W68*H65mm	1.6Kg	
Operating Temperature	Storage Temperature	Humidity Operating	Humidity Storage	Packing dimension	G.W	
-20 °C to +50 °C	-30 °C to +60 °C	10-80%RH	10-90%RH	L1530*W77*H77mm	1.8Kg	
Outer carton package	9*1layer=9PCS/carton,K=K corrugated paper , L1545*W250*H250mm,GW:17.3KG					
Optional dimming type	DALI Dimming					
Power Adjustable	0.35A —50W 、 0.3A —42W 、 0.25A —34W 、 0.2A —26W					

Test report

Item No.: **SR05-50W-1530**

1.5M

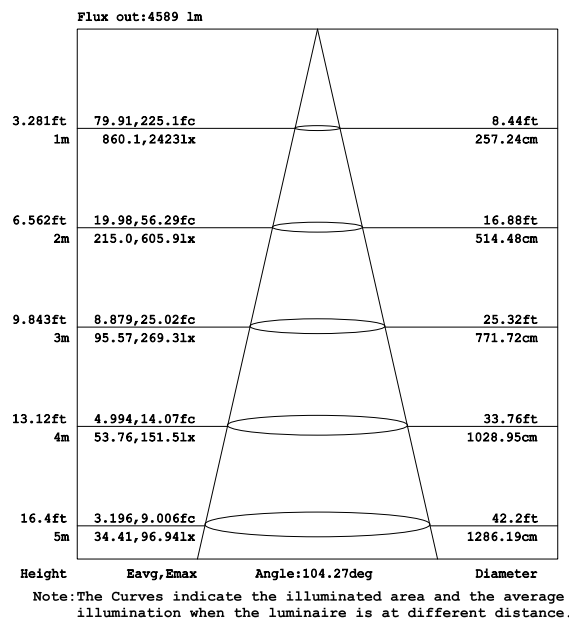
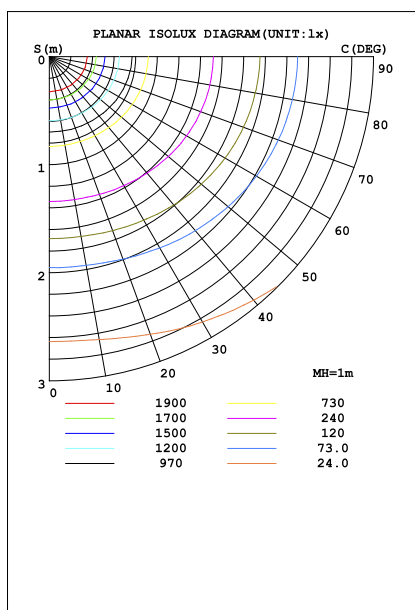
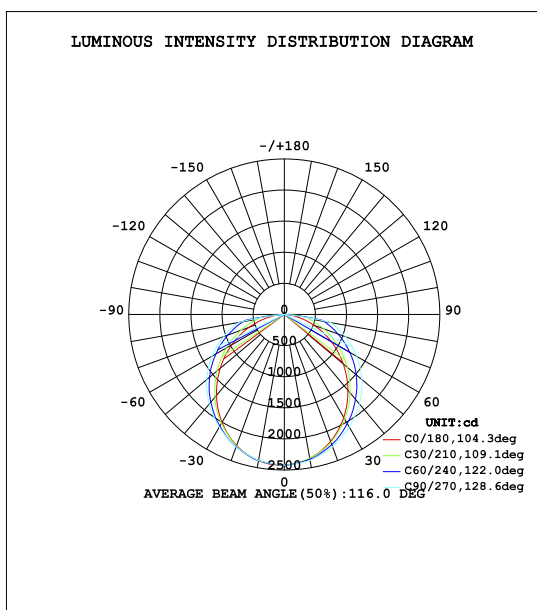

Manual Instruction

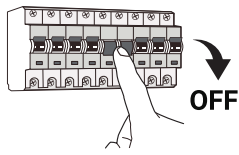

A : Turn off the power.

B ① Drill $\phi 6\text{mm}$ holes according to below drawing.

Include

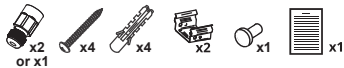

Not Include

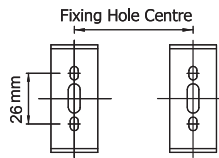

② Insert $\phi 6\text{mm}$ expansion pipe in the wall, fix the mounting bracket by M4 screw.

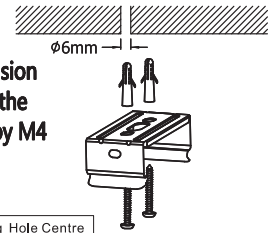

Model	Power	Fixing Hole Centre
SR05-18W-630	18W	300mm
SR05-36W-1230	36W	800mm
SR05-50W-1530	50W	1010mm

C ① Loosen the nut of the cable gland, put the cable through the cable gland.



② Connect the cable on the terminal block as below shown and tighten the cable gland

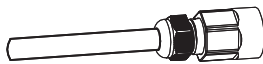

Prealigner Notch

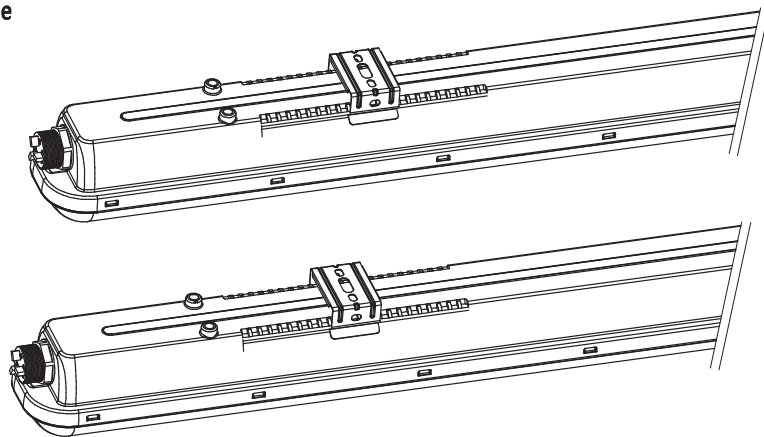

AC Input: AC200-240V

AC-L

DA 1 (Dim)

AC-N

DA 2 (Dim)

GND

③ Close the diffuser.

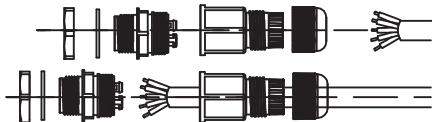
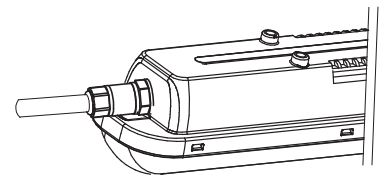

Five core wire

D ① Fix the lamp on the wall.

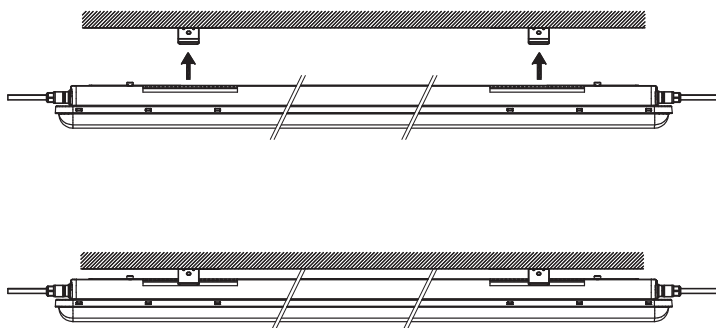

Safety Notice:

1. Electrical installation should be done by registered electrician only
2. Disconnect the luminaire from supply and wait until luminaire is cooled down, before replacement of the driver
3. Never touch the lamp while luminaire is switched on
4. In any case of malfunction disconnect luminaire from supply immediately, don't try to repair the luminaire yourself, repair should only be done by official service agent.

If In Series

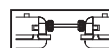

Model	Connection	Qty Max(pcs)
SR05-18W-630	QI	60
SR05-36W-1230	QI	30
SR05-50W-1530	QI	20

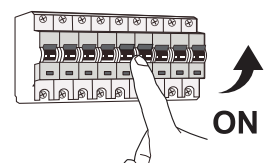

E : Turn on the power.

Packing Info



PE bag



Inner box
(1 PCS)



Outer Carton

Item No.	Power	Packing QTY
SR05-36W-1230	36W	9 pcs/carton
SR05-50W-1530	50W	9 pcs/carton

Cautions:

- 1.This product must be installed by professionals;
- 2.If there is any damage on the power line or shell, it should be taken as defective product and should not be used;
- 3.High voltage, non-professionals are not allowed to install, disassemble the product or connect wires.

Notes:

1. Please always use the light out of its package.
2. Before starting use of the light, please check if the light was damaged during transportation. If any damage shown, please DO not install or use it.
3. Any maintenance should be performed by trained professionals only.
4. Keep packaging material away from the reach of children and pets. Risk of suffocation!
5. Caution. The packaging contains small parts that may be swallowed by children.
6. Never leave children unattended in the vicinity of the lights and do not allow them to play with electrical devices.
7. Try to avoid looking directly in the LED beam-especially for extended periods of time. Do not shine the LED light in another person's eyes.
8. Never cover the lights by other objects.
9. Never allow the light to come into contact with open flames or external heat sources.
10. The products need to re-repair inspection or special treatment of retirement after service time
11. Non-professionals are not allowed to disassemble and maintain the products. We have the right not to provide after-slae service if unauthorized disassembly and maintenance happens to the products.